

Features

- Full blocking capability over wide temperature range
- Electrically insulated base plate
- Hard soldered joints for high reliability

Key Parameters

V_{RRM}	= 1800V
$I_{F(AV)}$	= 190A
I_{FSM}	= 6500A
$V_{F(TO)}$	= 0.85V
r_F	= 0.80mΩ

Applications

- Power Supplies
- Field supply for DC motors
- Uncontrolled Rectifiers

Symbol	Characteristic	Conditions	T _J [°C]	Value	Unit
BLOCKING					
V_{RRM}	Repetitive peak reverse voltage		150	200 - 1800	V
I_{RRM}	Repetitive peak reverse current	$V = V_{RRM}$	150	20	mA
CONDUCTING					
$I_{F(AV)}$	Mean forward current	180° sin ,50 Hz, T _{CASE} =100°C		190	A
I_{FRMS}	RMS forward current			298	A
I_{FSM}	Surge forward current	Sine wave, 10 ms Without reverse voltage	25	6500	A
			150	5600	A
$I^2 t$	$I^2 t$	Sine wave, 10 ms Without reverse voltage	25	211250	A ² s
			150	156800	A ² s
V_F	Forward voltage	Forward current = 500 A	25	1.32	V
$V_{F(TO)}$	Threshold voltage		150	0.85	V
r_F	Forward slope resistance		150	0.80	mΩ
MOUNTING					
$R_{th(j-c)}$	Thermal impedance, sin 180°	Junction to case, per arm per module		0.21 0.11	°C/W
$R_{th(c-h)}$	Thermal impedance	Case to heatsink, per arm per module		0.10 0.05	°C/W
T_j	Max. junction temperature			150	°C
T_{stg}	Storage temperature			-40 150	°C
V_{ISOL}	Insulation test voltage,RMS	F=50Hz, 1min		2.5	KV
M1	Mounting torque			5 ± 15%	Nm
M2	Terminal connection torque			5 ± 15%	Nm
	Weight (Approx.)			165	g

DISSIPATION CHARACTERISTICS PER ARM
SINE WAVE

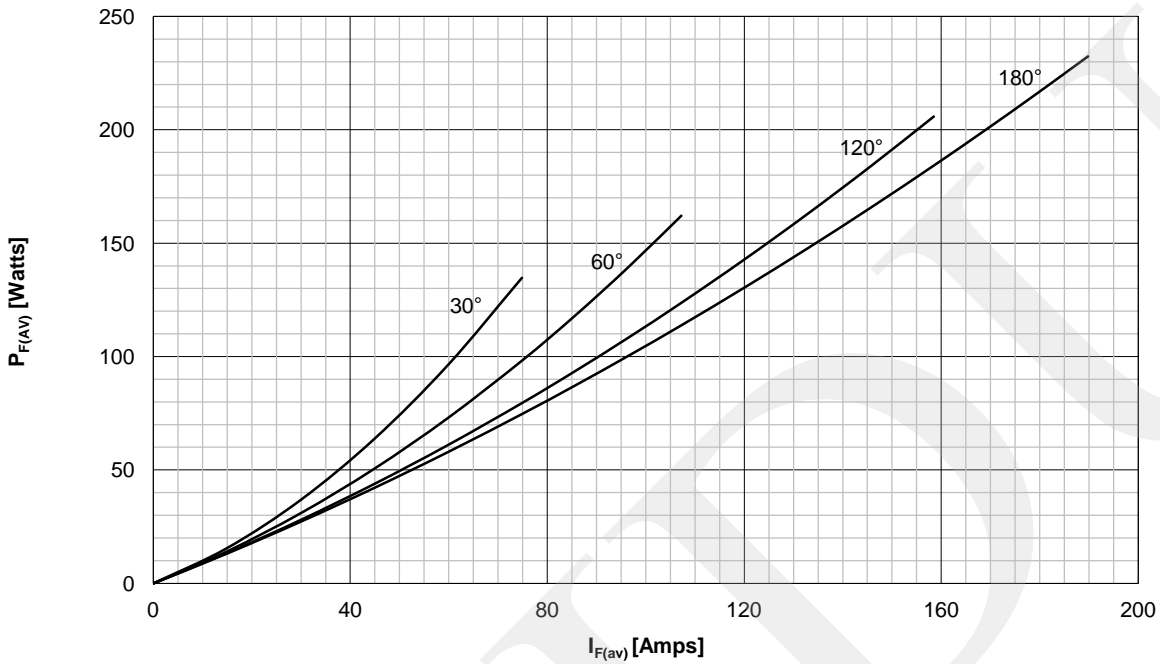

FORWARD CURRENT DERATING CURVE PER ARM
SINE WAVE

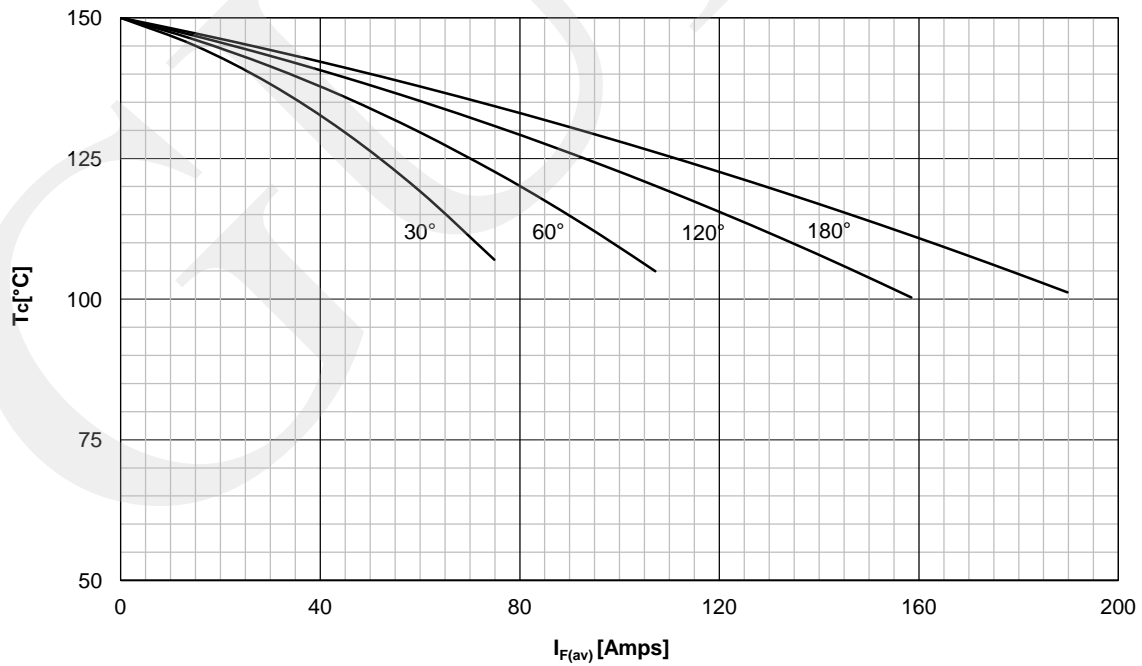

DISSIPATION CHARACTERISTICS PER ARM
SQUARE WAVE

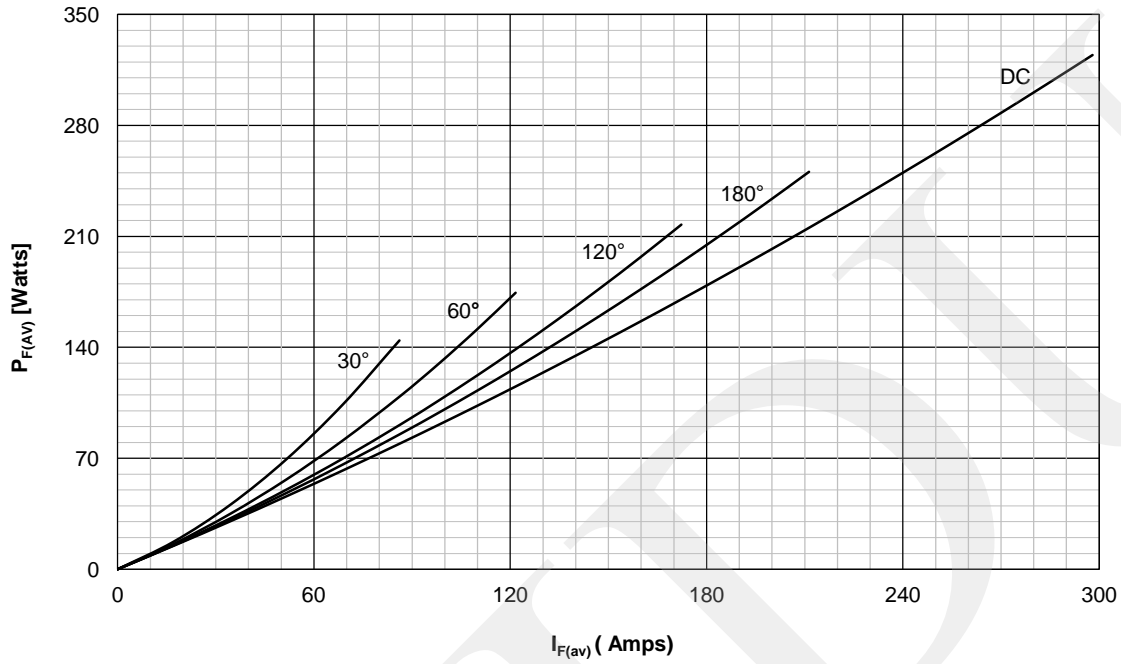

FORWARD CURRENT DERATING CURVE PER ARM
SQUARE WAVE

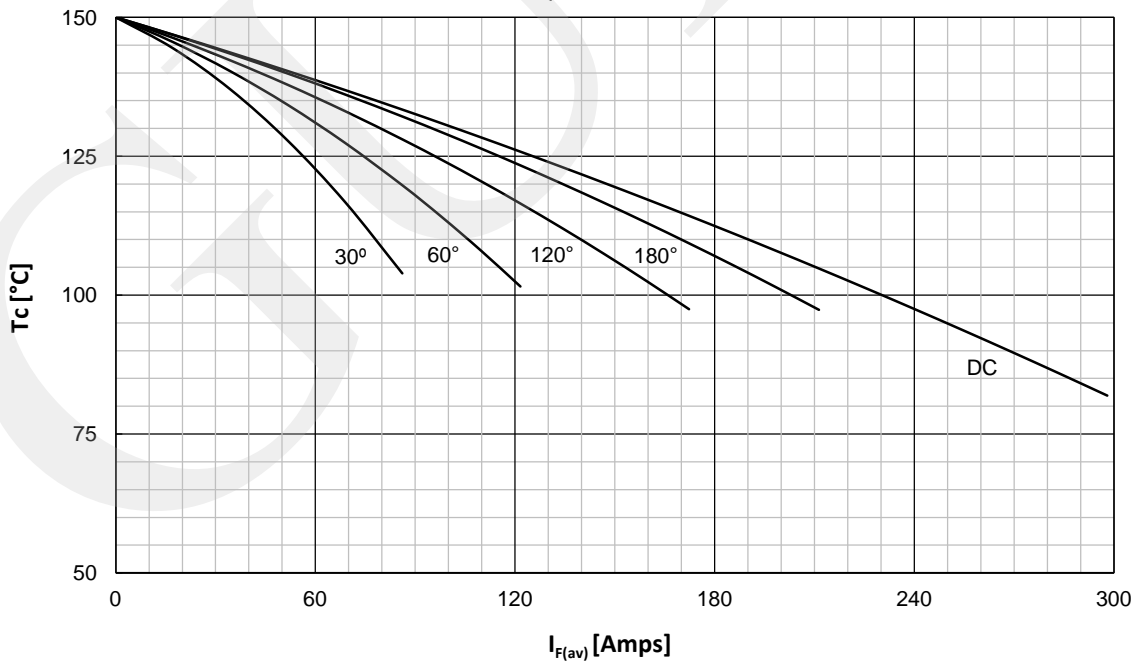

FORWARD CHARACTERISTICS

$T_j = 150^\circ\text{C}$

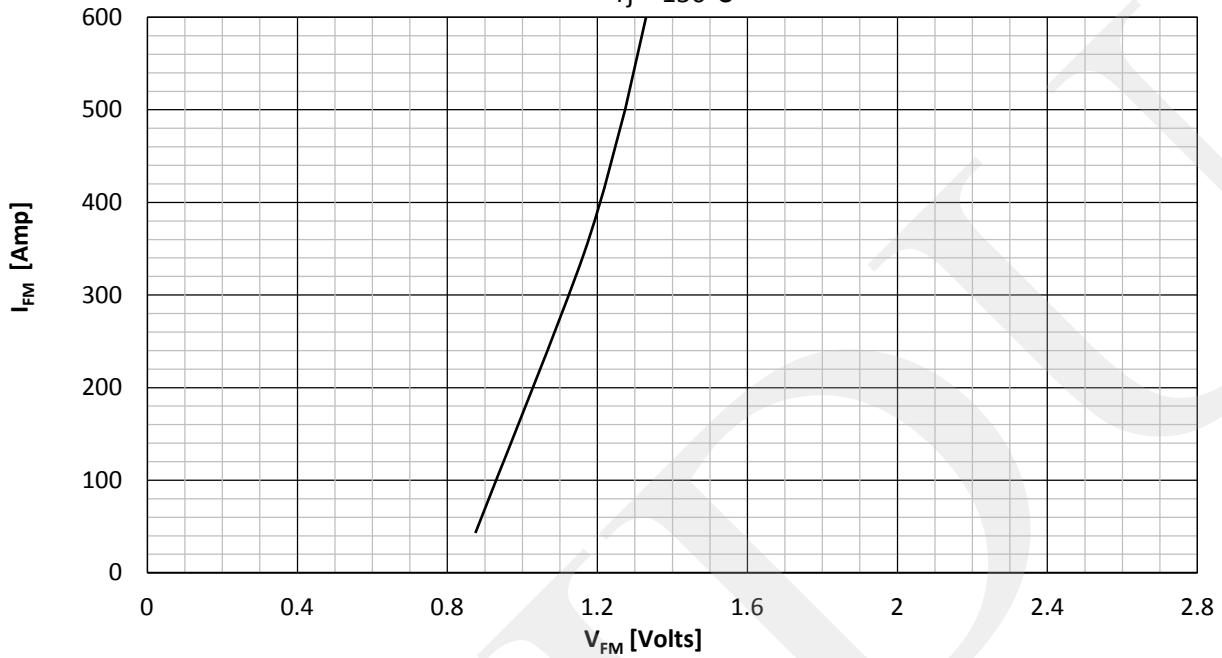

SURGE CHARACTERISTICS

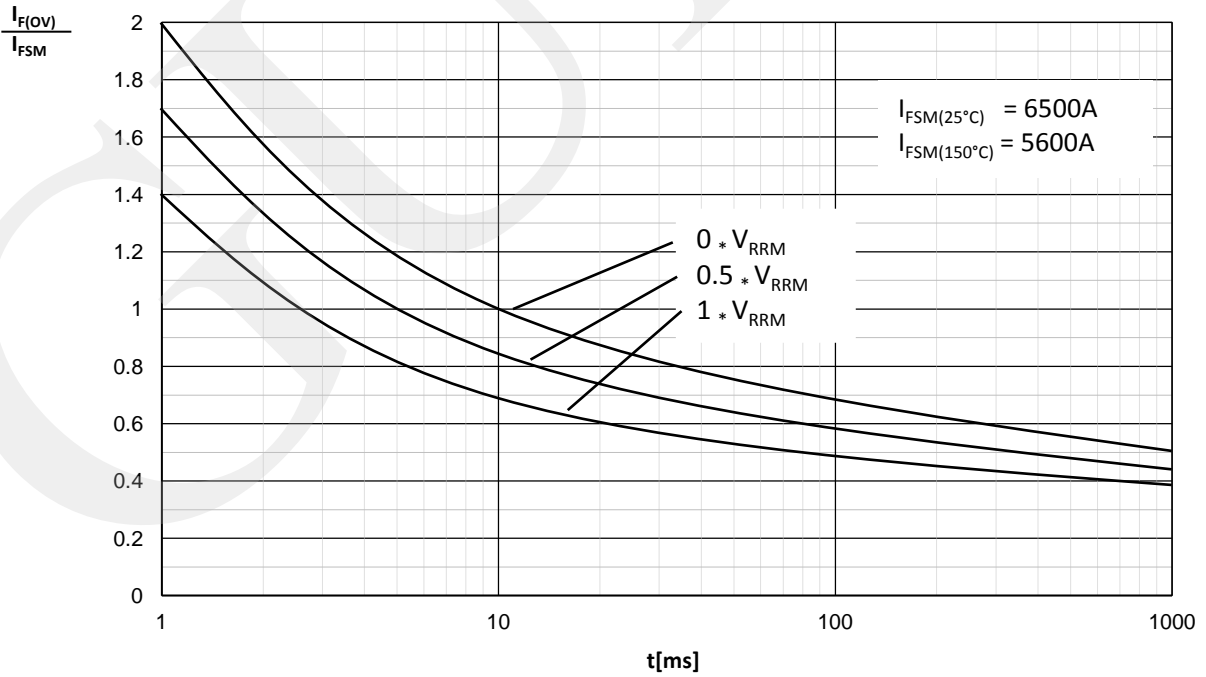

TRANSIENT THERMAL IMPEDANCE, PER ARM

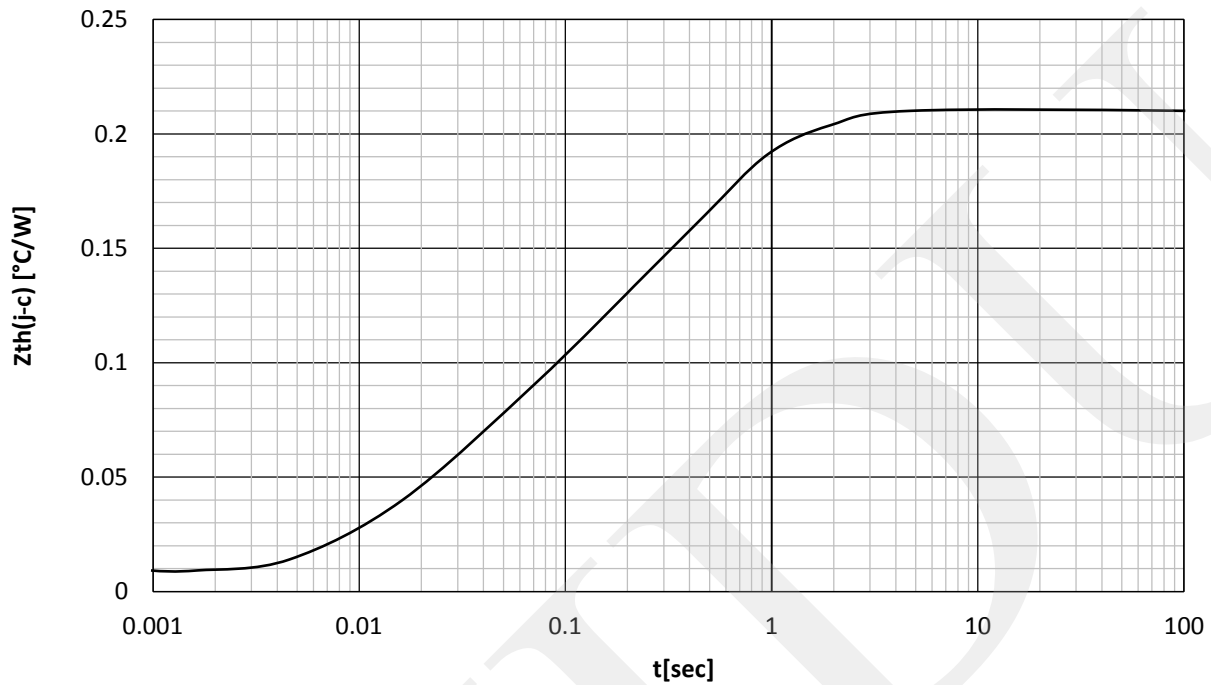

ORDERING INFORMATION

GD	DD	190	- X X	X X
Fixed code	DD- Diode- Diode Module	Current Code	Voltage Code Code X 100 = V_{RRM}	None - Standard connection AA - Common Anode KK - Common Cathode

Order Code GDDD190-18 KK : 1800V V_{RRM} , Common Cathode , Diode-Diode Module

Outline

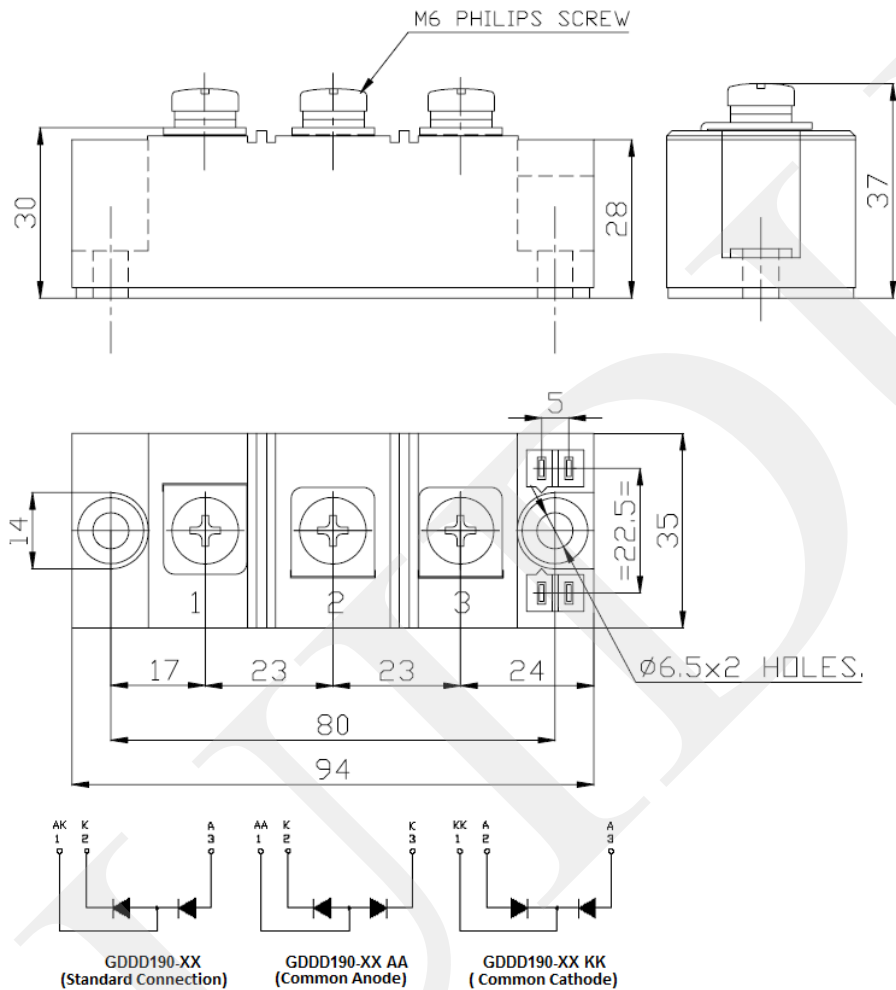

SHANGHAI GUIDU TECHNOLOGY CO., LTD.

No. 3398, Huqingping Rd., Qingpu,
Dist., Shanghai 201703, China

Tel.: +86 573 84828286

Fax.: +86 573 84828278

E-mail : sales@guidutech.com

www.guidutech.com

In the interest of product improvement, GUIDU reserves the right to change specifications at any time without prior notice